

WEDNESDAY

ITEM #5745176

MODEL #61096

Wednesday 10-FT Nevermore Academy Archway

ATTACH YOUR
RECEIPT HERE

WEDNESDAY © 2022 MGM Television.
Entertainment Inc. WEDNESDAY is a trademark
of Tee & Charles Addams Foundation.
© 2024 Metro-Goldwyn-Mayer Studios Inc.
All Rights Reserved.

TEKKY and the logo design are trademarks of JCW
Investments, Inc., d/b/a Tekky, and used under license.
TekkyDesign.com



DO NOT RETURN THIS ITEM TO THE STORE!

If experiencing technical difficulties, please go
to www.tekkydesign.com for assistance.

TABLE OF CONTENTS

Package Contents.....	3, 4
Safety Information and Preparation.....	5
Assembly Instructions.....	6 - 11
Operating Instructions.....	12
Care and Maintenance.....	13
Troubleshooting and FCC.....	14

PACKAGE CONTENTS

PART	DESCRIPTION	QUANTITY
1.	Right Side Metal Base (H)	1
2.	Left Side Metal Base (H1)	1
3.	Short Metal Base Frame Stabilizer (O, P)	4
4.	Long Metal Base Frame Stabilizer (P)	4
5.	Left Side Metal Lower Support Frame (G1, H1)	1
6.	Left Side Metal Mid Support Frame With Electrical Connectors (F1, G1)	1
7.	Left Side Upper Metal Frame With Tether & Electrical Connector (D1, E1, F1)	1
8.	Right Side Metal Lower Support Frame (G, H)	1
9.	Right Side Metal Mid Support Frame (F, G)	1
10.	Right Side Upper Metal Frame With Tether & Electrical Connector (D, E, F)	1

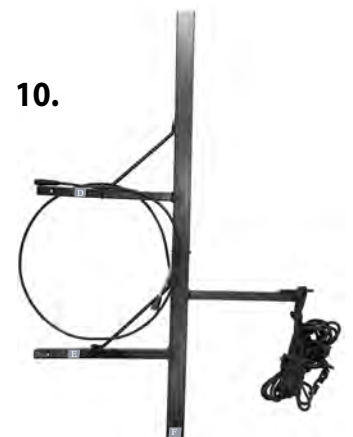
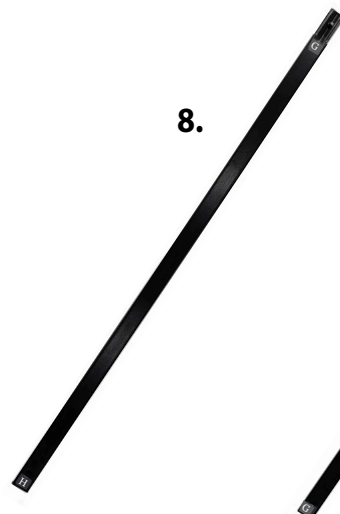
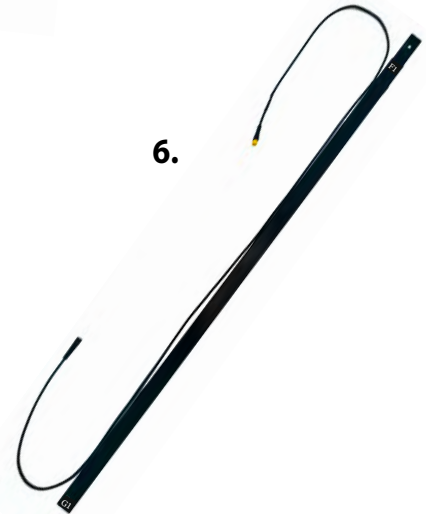
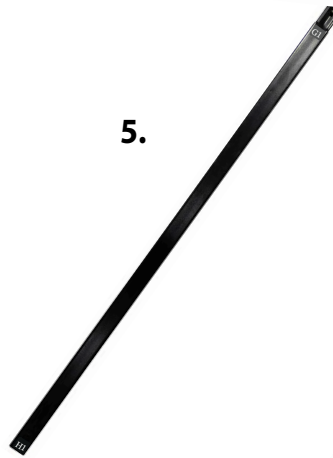

PACKAGE CONTENTS CONTINUED

PART	DESCRIPTION	QUANTITY
11.	Molded Plastic Column With Control Box / Speaker and IR Sensor, Right Side Base	1
12.	Molded Plastic 3-Block Column	2
13.	Molded Plastic 2-Block Colum (Has Opening For Lantern)	2
14.	Right & Left Side Molded Plastic Thin Column Ledge	2
15.	Right & Left Side Molded Plastic Thick Column Ledge	2
16.	Molded Plastic Column Left Side Base	1
17.	Right & Left Side Plastic Crow Topper	2
18.	Molded Plastic Lantern	2
19.	Metal and Plastic Left Side Archway	1
20.	Metal and Plastic Upper Center Archway	1
21.	Metal and Plastic Right Side Archway	1
22.	5.9 - 1.5V Adapter	1
23.	Nylon 10 lb. Capacity Sand Bag	2
24.	Metal Ground Stakes	8

11.



12.



13.



14.



15.



16.



17.



18.



19.



20.



21.



22.



23.



24.





SAFETY INFORMATION

Please read and understand this entire manual before attempting to assemble, operate, or install the product.



WARNING

- **Warning: Risk of injury to persons. Read and understand instruction manual before use.**
- Warning: CHOKING HAZARD! Small parts. This item is not a toy. For decoration only.
- Do not turn item on until you have completely finished assembly.
- Intended for indoor and outdoor use.
- Stay clear of item while operating.
- Do not place item on uneven ground.
- Do not place weight on item while in operation unless on the metal base.

PREPARATION

2 PERSON ADULT ASSEMBLY REQUIRED

Before beginning assembly of product, make sure all parts are present. Compare parts with package contents list. If any part is missing or damaged, do not attempt to assemble the product.

Estimated Assembly Time: 30 minutes

ASSEMBLY INSTRUCTIONS

Please Note : To begin assembly of the Wednesday Nevermore Academy Archway, you will need to assemble this with the parts face down on the floor as shown in illustration 1, 2 and 3. Due to that, please follow directions of "Left" and "Right" as you stand at the bottom of the Archway and follow the directions.

1. Snap-lock the Left Side Section (Part 20) to the Right Section (Part 18) by matching A to A and A to A. Connect electrical wires together by matching A1 to A1.



2. Please use two people to insert the Snap-locks of the Upper Center Section at the same time. When the total top sign is still facing the floor, Snap Lock B to B (on the left side) and Snap Lock C to C (on the right side).



3. Begin the metal frame structure build. Slide left side Thin Column Ledge (part 14) over Upper Metal Frame with tether and electrical connector (Part 7). Make sure slot on bottom is facing inward. Snap lock the Upper Metal Frame to the assembled sign by matching D1 to D1 and E1 to E1. Connect the electrical wires on the top of the frame to the wires on the sign by matching A2 to A2.

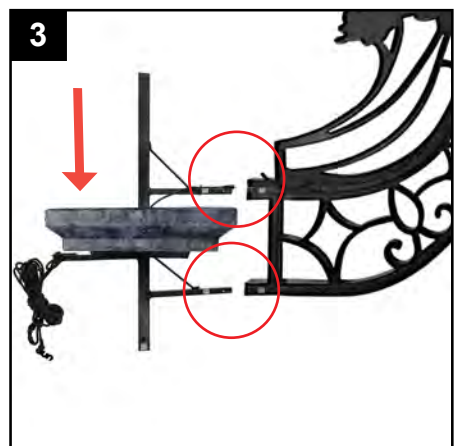

ASSEMBLY INSTRUCTIONS

4. Slide right side Thin Column Ledge (part 14) over Upper Metal Frame with tether and electrical connector (Part 10). Make sure slot on bottom is facing inward. Snap lock to the assembled sign by matching D to D and E to E. Connect the electrical wires from the sign to the wires of the top of the metal frame by matching A5 to A5.

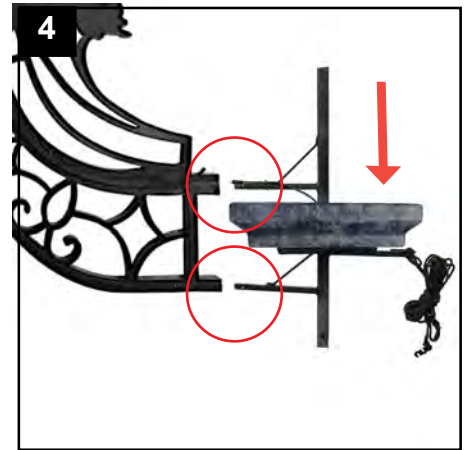

5. Snap lock the Right Side Metal Mid Support Frame (Part 9) the Upper Metal Frame with tether and electrical connectors (Part 7) by matching F to F.

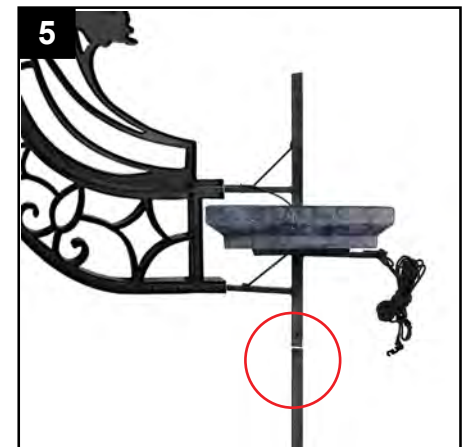

6. Snap-lock the Right Side Lower Metal Frame Support pole (Part 8) to the Mid Right Side Metal Frame Support Pole (Part 9) by matching G to G.

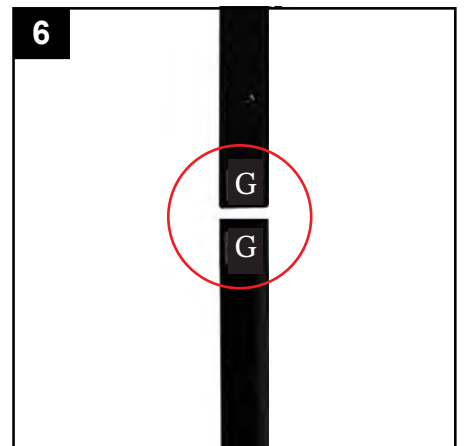

7. Snap lock the Left Side Metal Mid Support Frame (Part 6) the Upper Metal Frame with tether and electrical connectors (Part 7) by matching F1 to F1.

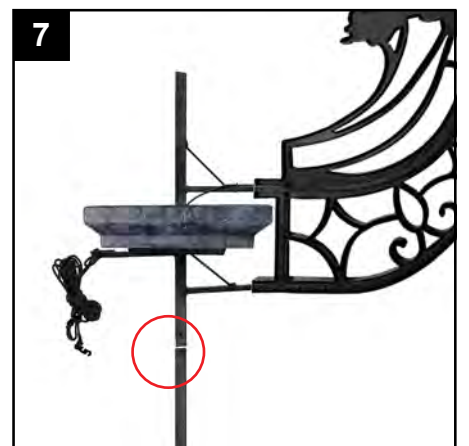

ASSEMBLY INSTRUCTIONS

8. Snap-lock the Left Side Lower Metal Frame Support pole (Part 5) to the Mid Left Side Metal Frame Support Pole (Part 6) by matching G1 to G1.

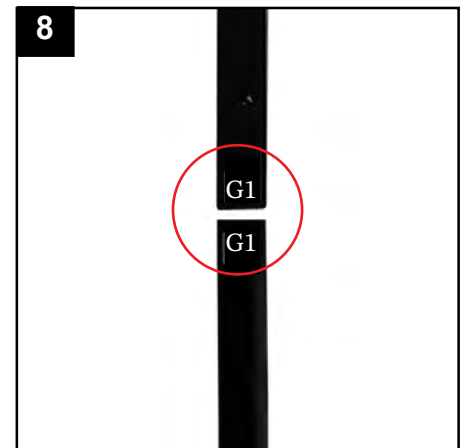

9. Slide the Molded Plastic 2-Block Column, opening for lantern facing the floor (Part 13) and slide up from the bottom of the assembled left side metal frame. Run the wires from the top through.

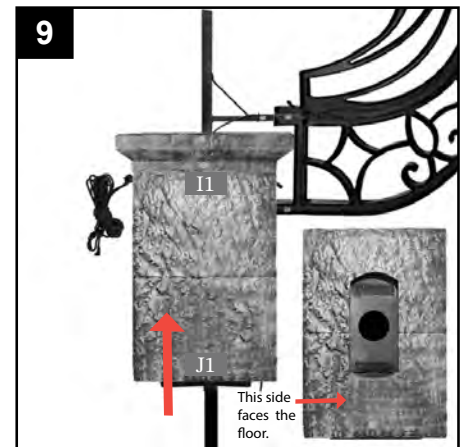

10. Repeat Step 9 to the other side.

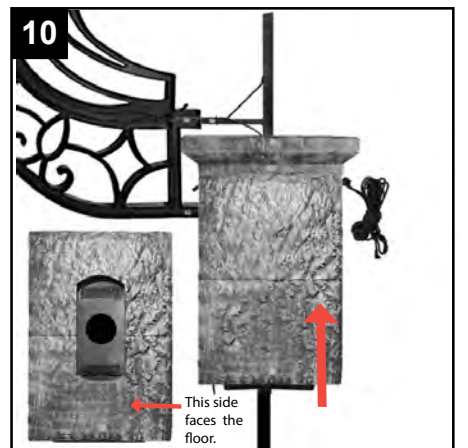

11. Slide Plastic Molded 3-Block Column (Part 12) up from the bottom and pull the wires through so they can connect to the control box in upcoming steps.

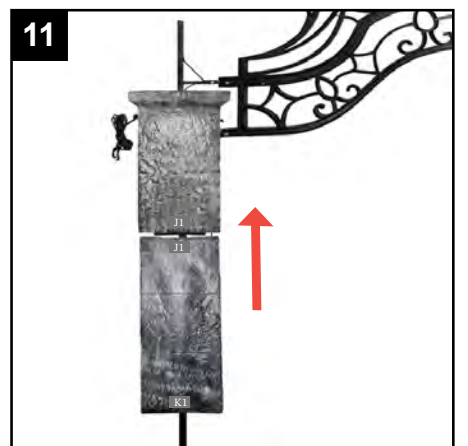

ASSEMBLY INSTRUCTIONS

12. Slide the Right Side Plastic Molded 3-Block Column (Part 12) up from the bottom and match to the 2-Block part. Please note that there are no wires that go through on this side.

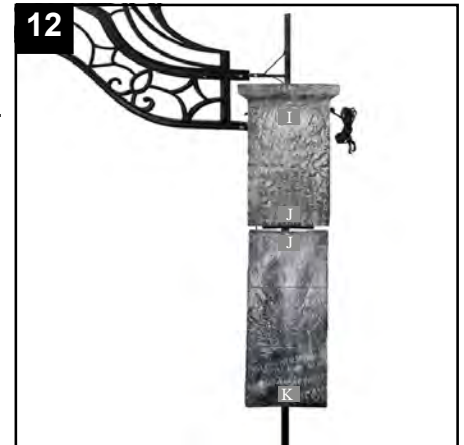

13. Slide the Plastic Molded Left Side Bottom of the Column (Part 11) up from the bottom and attach the wires coming through Part 12, to the wires coming out from the Control Box on the inside by matching both A3 wires to both A3 wires. Please note that the speaker should be facing up and the IR Sensor should be facing the floor.

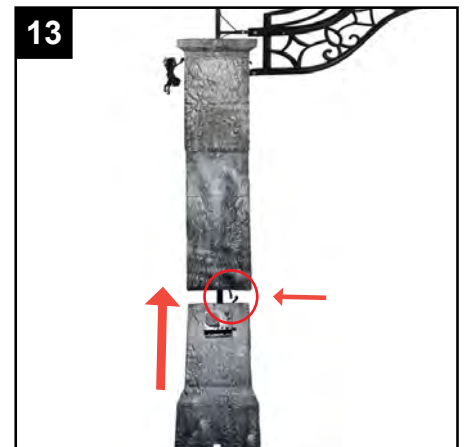

14. Slide the Plastic Molded Right Side Bottom of the Column (Part 16) up from the bottom and match up to the Plastic Molded 3-Block Column (Part 12). Please note that there are no wires that go through on this side.

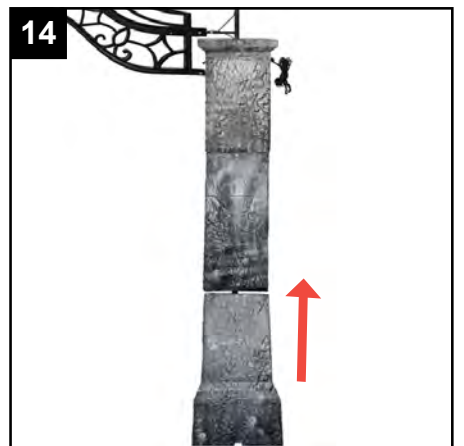

15. After all of the lower Molded Plastic Columns are in place and the electrical wires all connected, Snap Lock the Right Side Metal Base (Part 1) to the Right Side Metal Lower Support Frame (Part 8) by matching H to H. Do the same to the Left Side by matching H1 to H1.

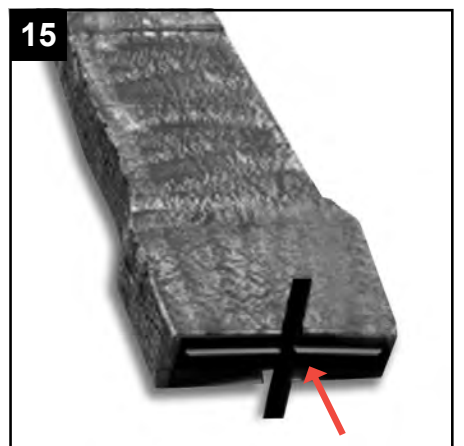

ASSEMBLY INSTRUCTIONS

16. With the archway still flat on the floor and the Metal Base attached, connect the Short Metal Base Frame Stabilizer (Part 3) by matching O to O. Then Snap Lock the Long Metal Base Frame Stabilizer (Part 4) to Part 3 by matching P to P.

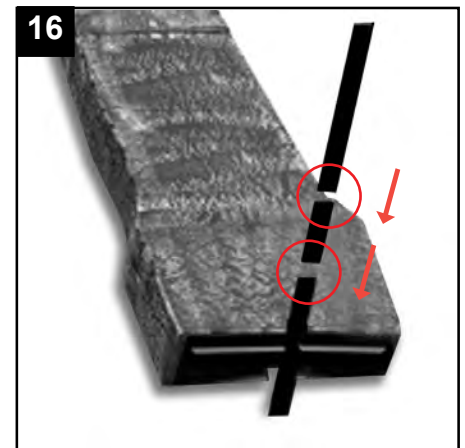

17. Repeat Step 16 on the left side.

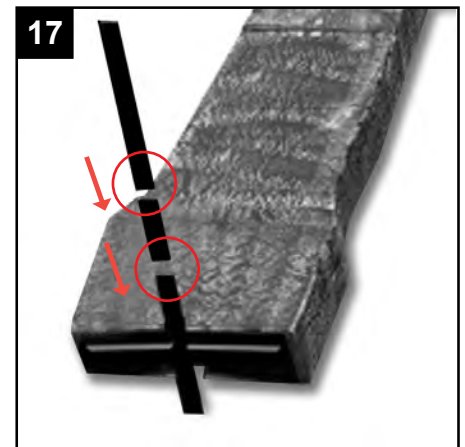

18. With two or more people, carefully lift the Archway up by holding on to upper exposed metal frame (on both sides).

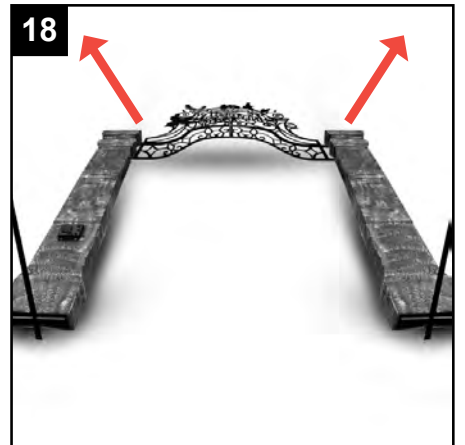

19. Once Archway is standing up, have one or two people hold for stability and an other person repeat steps 17 and 18 on the lower front (Right and Left) sides of the archway.

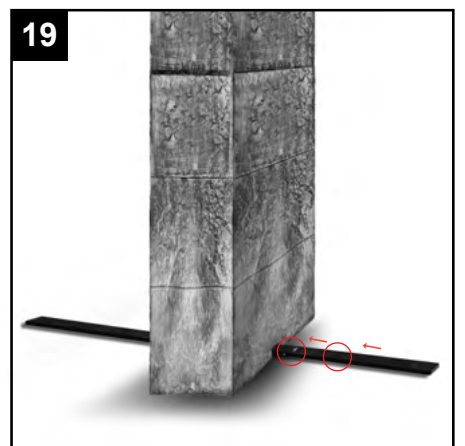

ASSEMBLY INSTRUCTIONS

20. Slide the Molded Plastic Thick Column Ledge (Part 15) over the top of the Upper Metal Frame on the left side, then place the Molded Plastic Crows (Part 17) over the top of each exposed upper Metal Frames. Please note that the Crows are to point inwards.

Repeat this step for the right side.

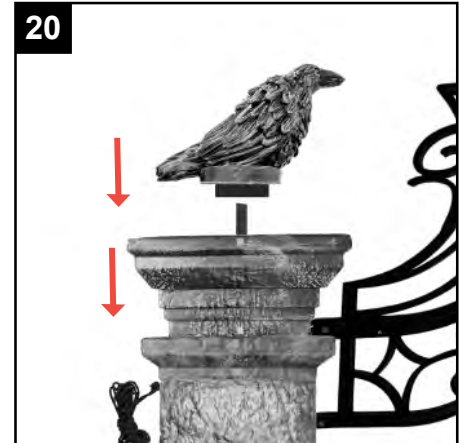

21. Reach into the opening on the front Right side of the Plastic Column and gently pull the wire for the lantern through the opening. Connect the wires by matching A4 to A4 of the Lantern (Part 18) and line up the hook and loop and gently press the Lantern into Place. Repeat this step for the Left side of the column by matching the wires A6 to A6.

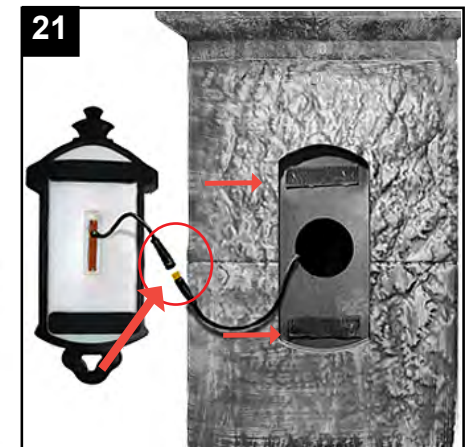

22. Plug 5.9A/ 1.5V Adapter into Control Box and then into safe electrical outlet.

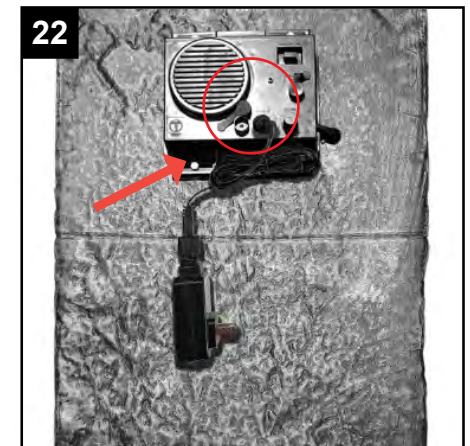

23. For additional stability on soft ground, untie the tethers and pull out one towards the front at a 45° angle. Secure to the ground Stake. Pull the other out towards the back at 45° and repeat. Repeat the same steps for the other side.

Inset on the right is a close up of the Toggle Lock that is secured to the end of each tether.

Also included are 4 flat top ground stakes to place over the front frame as well as the back.

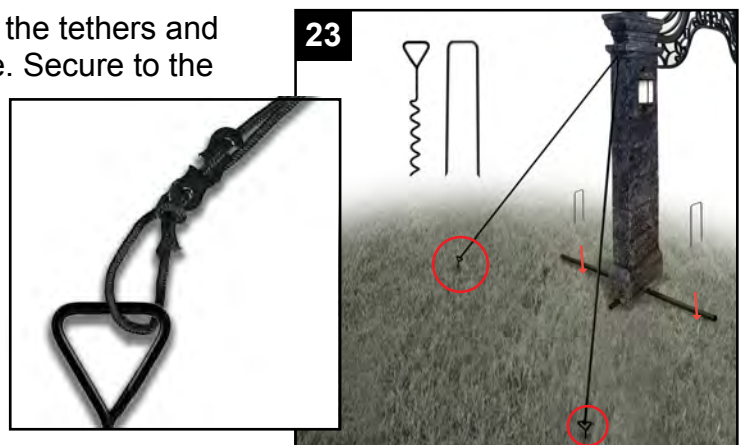

OPERATING INSTRUCTIONS

1. Insert the 5.9V 1.5 A ADAPTER (Part 22) in to the CONTROL BOX. Make sure it is fully secure by twisting it tight.



2. Move the switch to the ON position. Move in front of the item or make a loud sound (clap) to activate the item.

Turn the item to the OFF (DEMO) position when not in use.



OPTIONAL DEMO SET UP

FOOTPAD/PUSH BUTTON IS NOT INCLUDED. MUST BE PURCHASED SEPARATELY.

1. Insert the cable from optional footpad/push button into the jack labeled DEMO on the CONTROL BOX.
2. Place the switch in the DEMO position to enable DEMO activation.
3. Step on the FOOTPAD or press push button to activate the scary sequence!

* Footpads and push buttons are sold separately and can be purchased at www.tekkyaccessories.com



OPTIONAL EXTERNAL SPEAKER SET UP

EXTERNAL SPEAKER IS NOT INCLUDED. MUST BE PURCHASED SEPARATELY.

1. Plug speaker cord into the jack labeled SPEAKER JACK located on the CONTROL BOX.
2. Use volume knob on external speaker to control volume levels.



CARE AND MAINTENANCE

- STORE IN A COOL AND DRY ENVIRONMENT.
- SURFACE WASHABLE ONLY. DO NOT USE ANY HARSH OR ABRASIVE CLEANING AGENTS.
- DESIGNED FOR SEASONAL OPERATION ONLY.
- NOT INTENDED FOR CONSTANT OR LONG-TERM USE.
- PROPER STORAGE AND USE ARE ESSENTIAL TO THIS ITEM'S LONGEVITY.
- INTENDED FOR INDOOR USE ONLY.

TROUBLESHOOTING

PROBLEM	POSSIBLE CAUSE	CORRECTIVE ACTION
Item will not activate.	<ul style="list-style-type: none">• 5V-1.5A adapter is not plugged in.• Switch on control box is not in the ON position.• Human sensor on chest blister may be blocked.	<ul style="list-style-type: none">• Check 5V-1.5 A adapter is plugged in and securely inserted into the control box.• Move switch to ON position.• Move any obstructions away from the pants.
You only hear item sound but no item activation.	<ul style="list-style-type: none">• Control box wires are not connected	<ul style="list-style-type: none">• Check that wires labeled A3 are securely connected to the other wires labeled A3.
Item has no sound while operating.	<ul style="list-style-type: none">• Volume knob is turned all the way down.	<ul style="list-style-type: none">• Adjust volume knob to desired volume.

FCC REGULATION

FCC STATEMENT

FCC RULES: This device complies with Part 15 of the FCC Rules. Operation is subject to the following two conditions: (1) this device may not cause harmful interference, and (2) this device must accept any interference received, including interference that may cause undesired operation.

CAUTION: Changes or modifications not expressly approved by the party responsible for compliance could void the user's authority to operate the equipment.

NOTE: This equipment has been tested and found to comply with the limits for a Class B digital device, pursuant to Part 15 of the FCC Rules. These limits are designed to provide reasonable protection against harmful interference in a residential installation. This equipment generates, uses, and can radiate radio frequency energy and, if not installed and used in accordance with the instructions, may cause harmful interference to radio communications. However, there is no guarantee that interference will not occur in a particular installation. If this equipment does cause harmful interference to radio or television reception, which can be determined by turning the equipment off and on, the user is encouraged to try to correct the interference by one or more of the following measures:

- Reorient or relocate the receiving antenna.
- Increase the distance between the equipment and receiver.
- Connect the equipment into an outlet on a circuit different from that to which the receiver is connected.
- Consult the dealer or an experienced radio/TV technician for help.