

CHAINED TO THE GRAVE

TOMBSTONE LIFTER



Setup instructions:

PARTS:

1. HEAD WITH POLE & CLOTHING
2. BASE WITH POLE
3. FEET (2)
4. TOMBSTONE (2 HALVES)
5. ARMS (2)
6. SPIKES (3)
7. FOG CORD

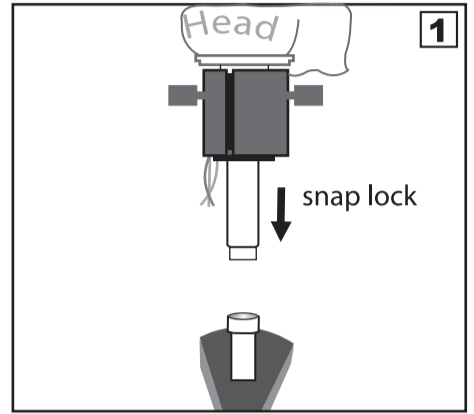

1. Snap lock **HEAD WITH POLE & CLOTHING** to **BASE WITH POLE**.

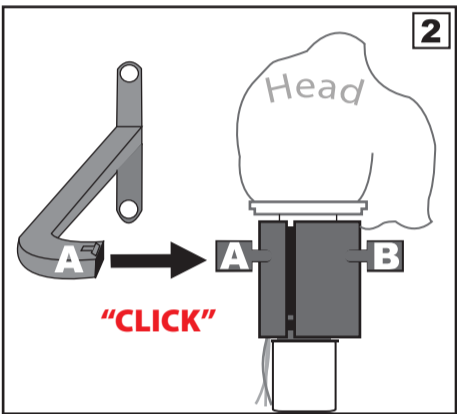

2. Insert **ARM** into arm socket under **HEAD WITH POLE & CLOTHING** (Match **A** to **A**). Press until you hear a "click."

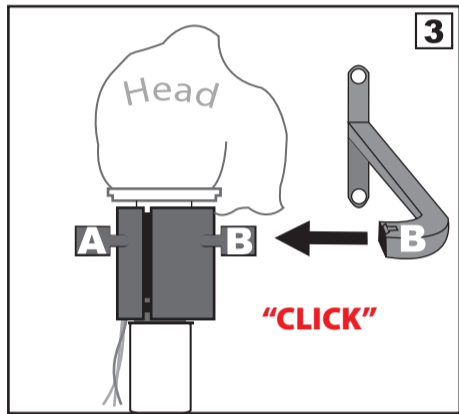

3. Repeat for other **ARM** labeled **B**.

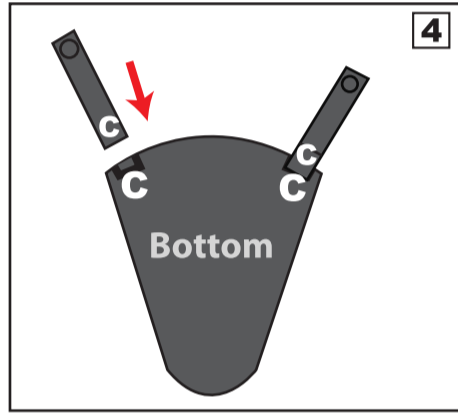

4. Insert **FEET** into bottom of **BASE WITH POLE**. (Match **C** to **C**).

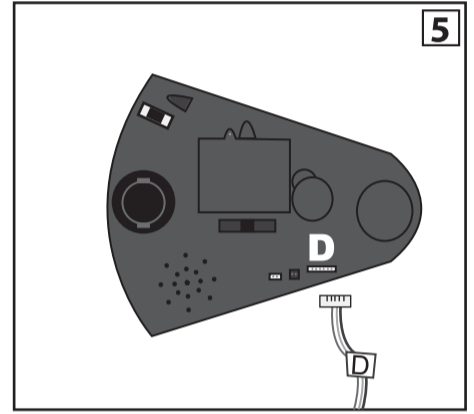

5. Insert cable labeled **D** into jack labeled **D** on **BASE WITH POLE**.

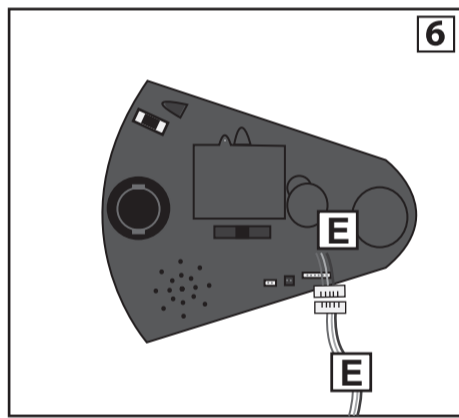

6. Insert cable labeled **E** into jack on cable labeled **E**.

TOMBSTONE ASSEMBLY

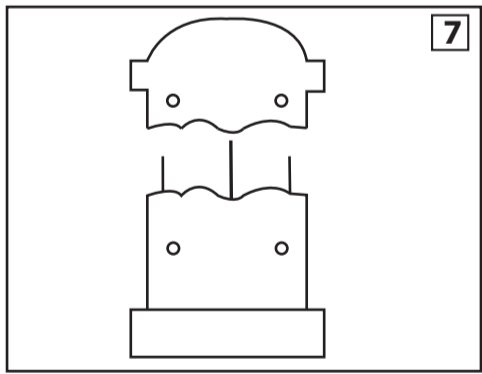

7. Insert **SPIKES** into bottom 1/2 of **TOMBSTONE**. Then, attach top 1/2 of **TOMBSTONE**.

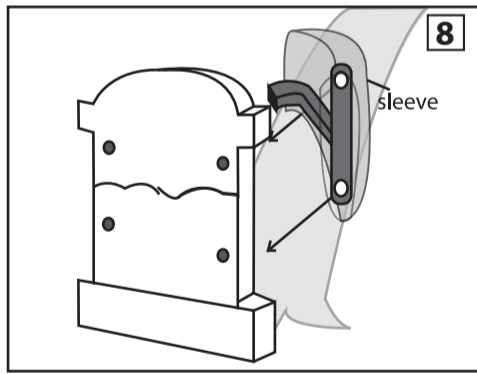

8. Place **SNAPS** seated in **TOMBSTONE** into holes on **ARMS**.

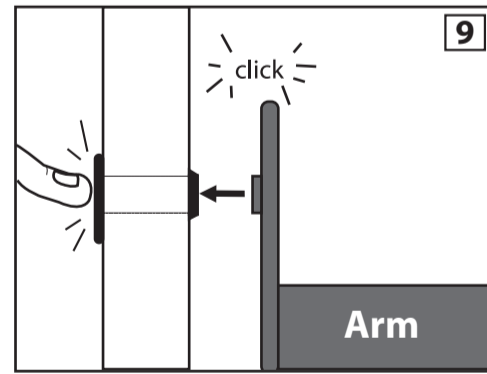

9. Holding **SNAPS** in place, firmly press **ARMS** onto **SNAPS** until they "click" and will not pull off easily.

10. Release tie holding clothes and insert cable **F** into jack labeled **F** on **TOMBSTONE**, and attach hook and loop fasteners on sleeves to fasteners on sides of **TOMBSTONE**.

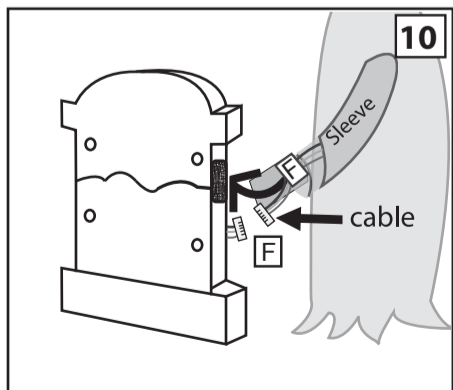

11. Attach hook and loop fasteners under sleeves to fasteners on lower part of **ARMS**.

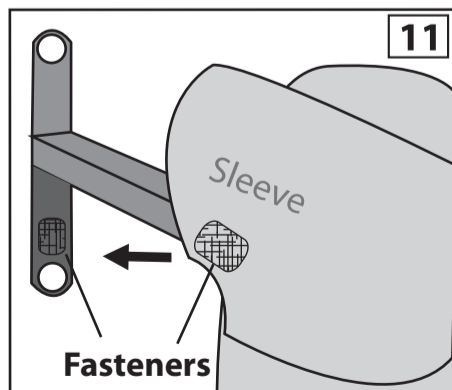

12. Attach hook and loop fastener on back of **BASE WITH POLE** to fastener under clothing.

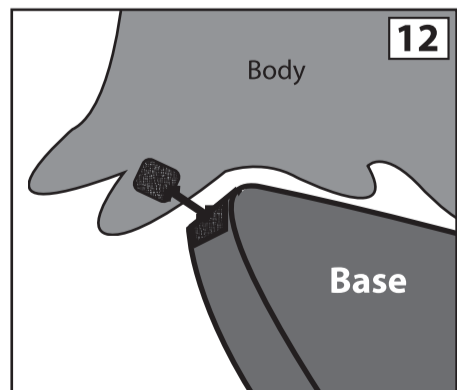

Setup instructions: Continued

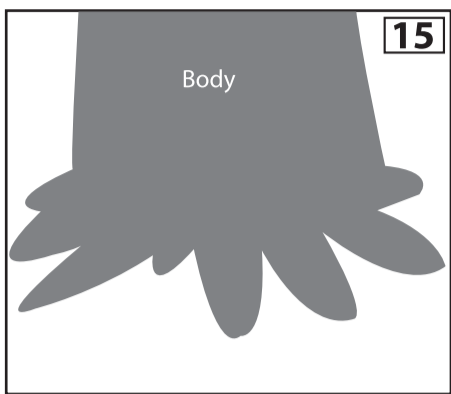
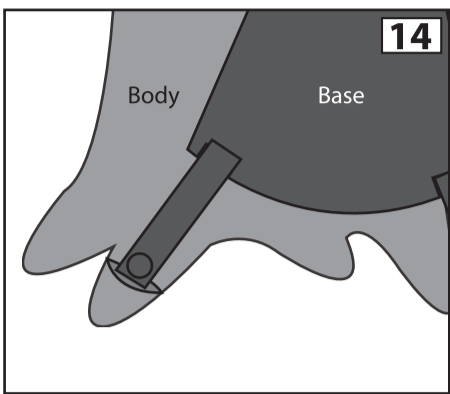
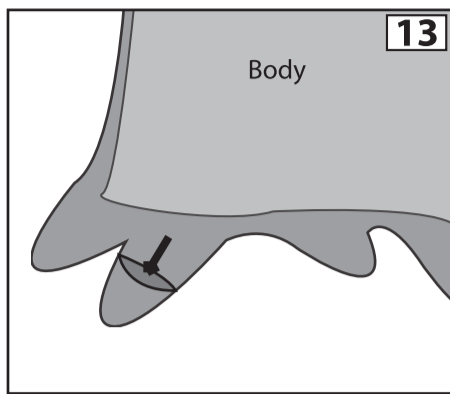

13. Locate fabric pockets on bottom of clothing and open.
14. Slide both **FEET** into pockets.
15. Spread out clothing on bottom as shown.
16. Insert batteries (4"AA") into battery compartment located on **BASE WITH POLE**, or
17. Connect 6 V 2A DC adapter. (Sold separately)

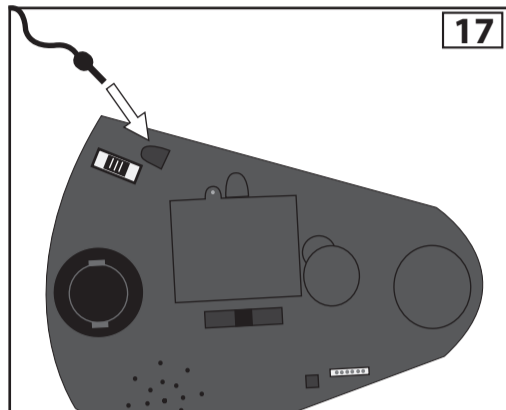
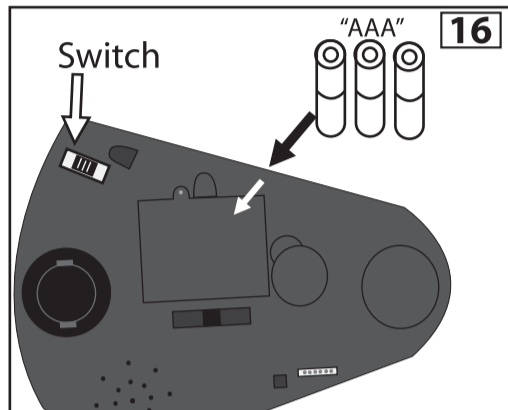

Turn switch on top of BASE to ON to operate in Timer/Sound mode (Item will function with 2 minute breaks between cycles - or, clap during 2 minute break to instantly start item playing again) Leave switch in OFF position when not in use.

OPTIONAL FOOTPAD SETUP

Follow initial installation instruction first.

1. Connect wire from optional footpad to the jack labeled FOOTPAD located on the base.
2. Place the switch on the base into 'FOOTPAD' position to enable FOOTPAD activation.
3. Step on FOOTPAD to activate the scary sequence.

NOTE:

When plugging in, make sure pins line up properly with holes on plug. Align plug, groove side down, with the notch.

CAUTION!

Not aligning the plug to jack properly may cause permanent damage to Footpad jack of your item. **DO NOT** use excessive force when inserting plug.

*Footpads are sold separately and can be purchased in Spirit Halloween stores or online at: www.spirithalloween.com

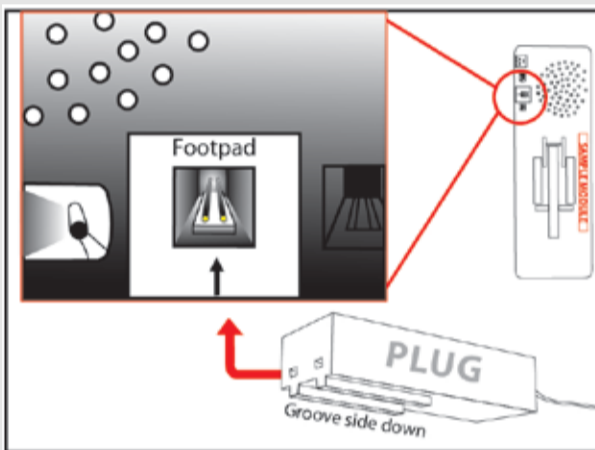

***** No weight should be placed on the item. *****

Caution:

Do not touch cords, or any part connected when plugged in.
Do not operate in wind/rain.
Do not operate until you have completely finished assembly.
For best overall performance, please shut off when not in use.



DO NOT RETURN THIS ITEM TO THE STORE!
If experiencing technical difficulties, please go to www.tekkytoys.com.

SMART PHONE SCAN SETUP VIDEO



HINTS FOR BETTER PERFORMANCE

Make sure to place Chained to the Grave on the level ground to ensure best operation.
Place weight on base or feet to increase stability.
Keep area around Chained to the Grave clear of obstructions.

OPTIONAL FOG MACHINE SETUP INSTRUCTIONS:

FOG MACHINE IS NOT INCLUDED. MUST BE PURCHASED SEPARATELY.

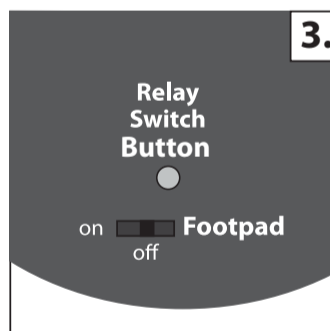
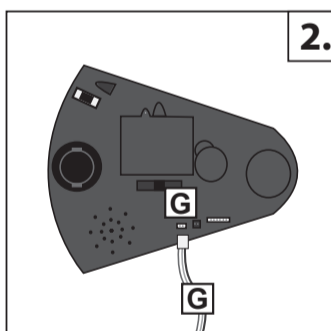
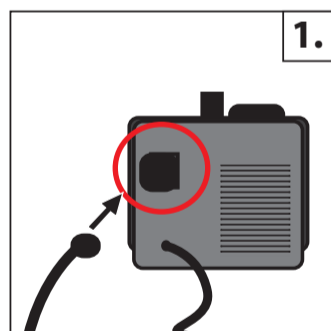

OPTIONAL FOG ATTACHMENT SETUP:

Your Fog MACHINE (select models) can be used in connection with select items.
Only attach a FOG MACHINE as instructed below.

*****Make sure Item is set to the OFF position and your FOG MACHINE is not turned on*****

1. Plug the Item's FOG CORD into your FOG MACHINE. IF FOG CORD will not plug in, or your machine does not interface with the item, we recommend that you not use optional fog attachment.
2. Plug other end of FOG CORD into BASE of item matching G to G.
3. Make sure your FOG MACHINE is heated up properly, then turn item's switch to the ON position. If fog does not appear from item, try pressing the relay switch button on the BASE.

